

STEGOSAURUS
February
2006
✱

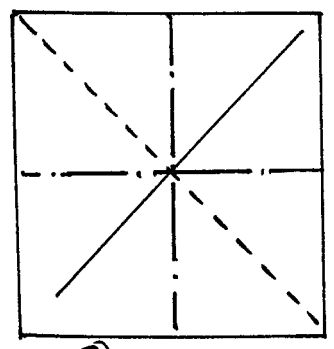

① preliminary base

↖

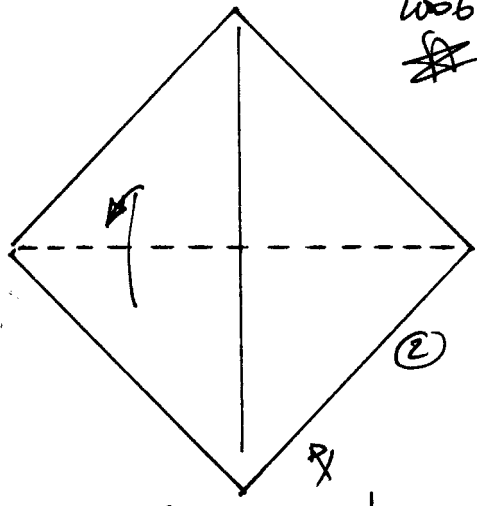

crease repeat behind

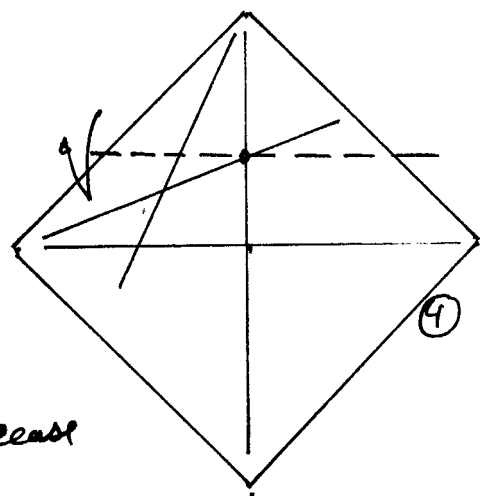

crease

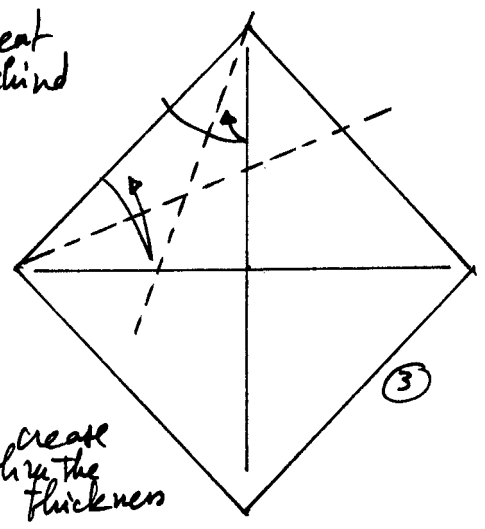

crease thru the thickness

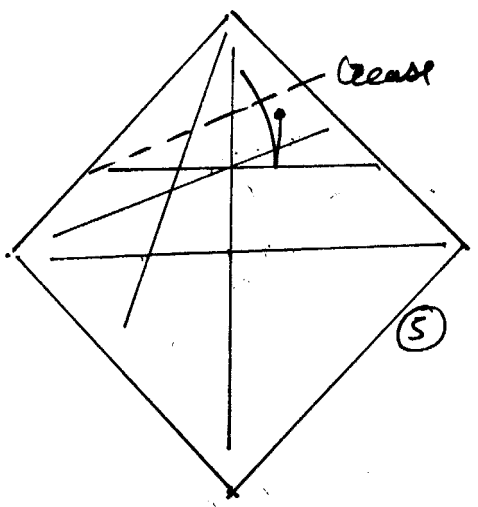

crease

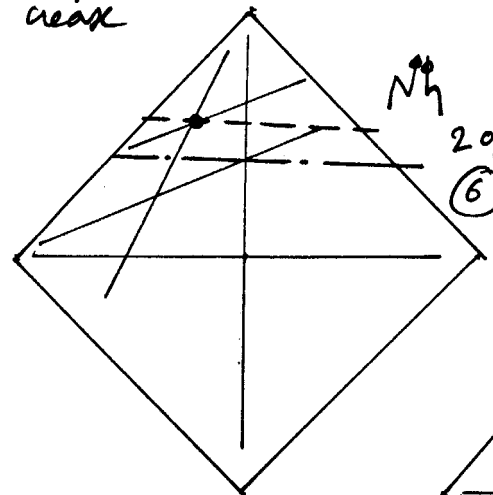

2 open ends

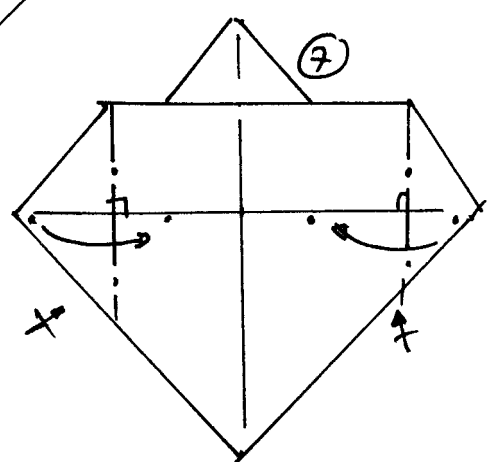

4 inside reverse folds

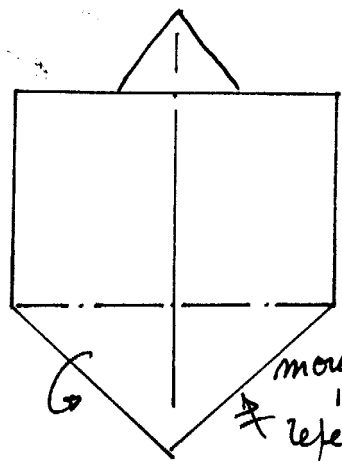

mountain inside repeat behind

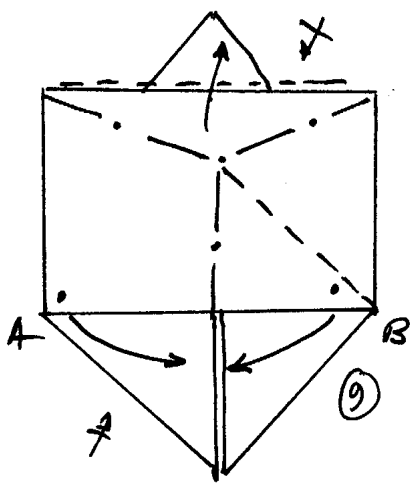

bring A to B
together
repeat behind

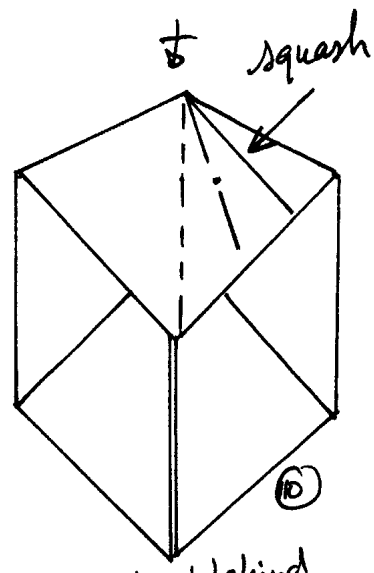

repeat behind

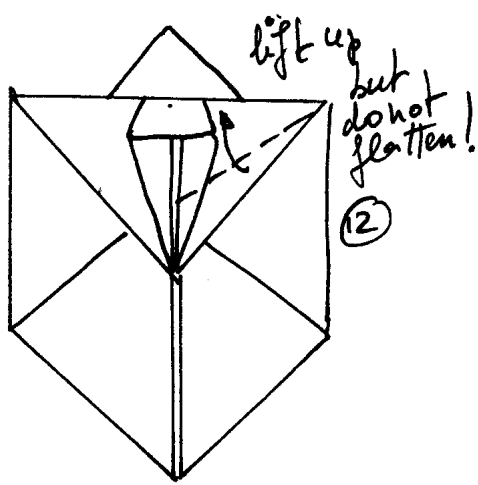

12

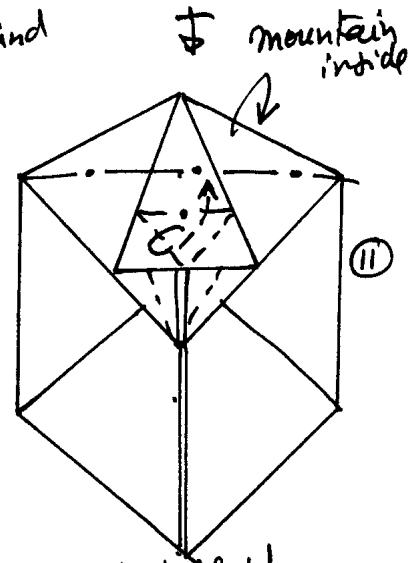

petal fold
inside
repeat behind

valley flap down back

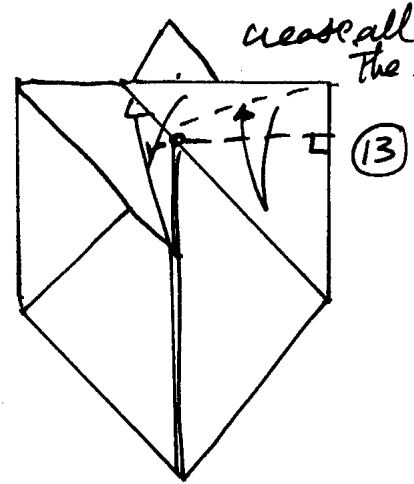

13

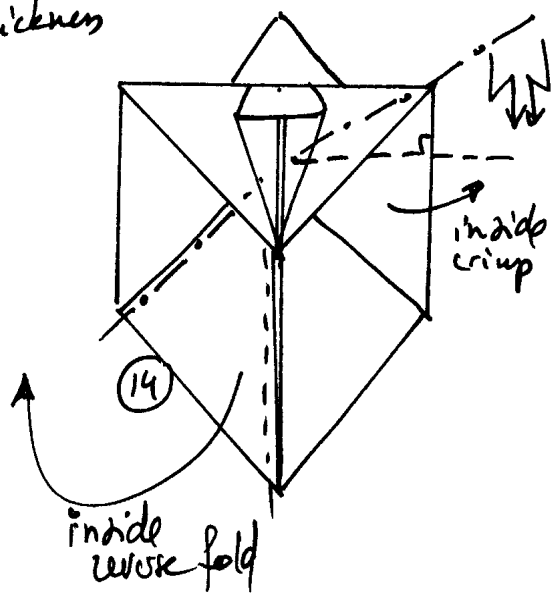

inside
crease fold

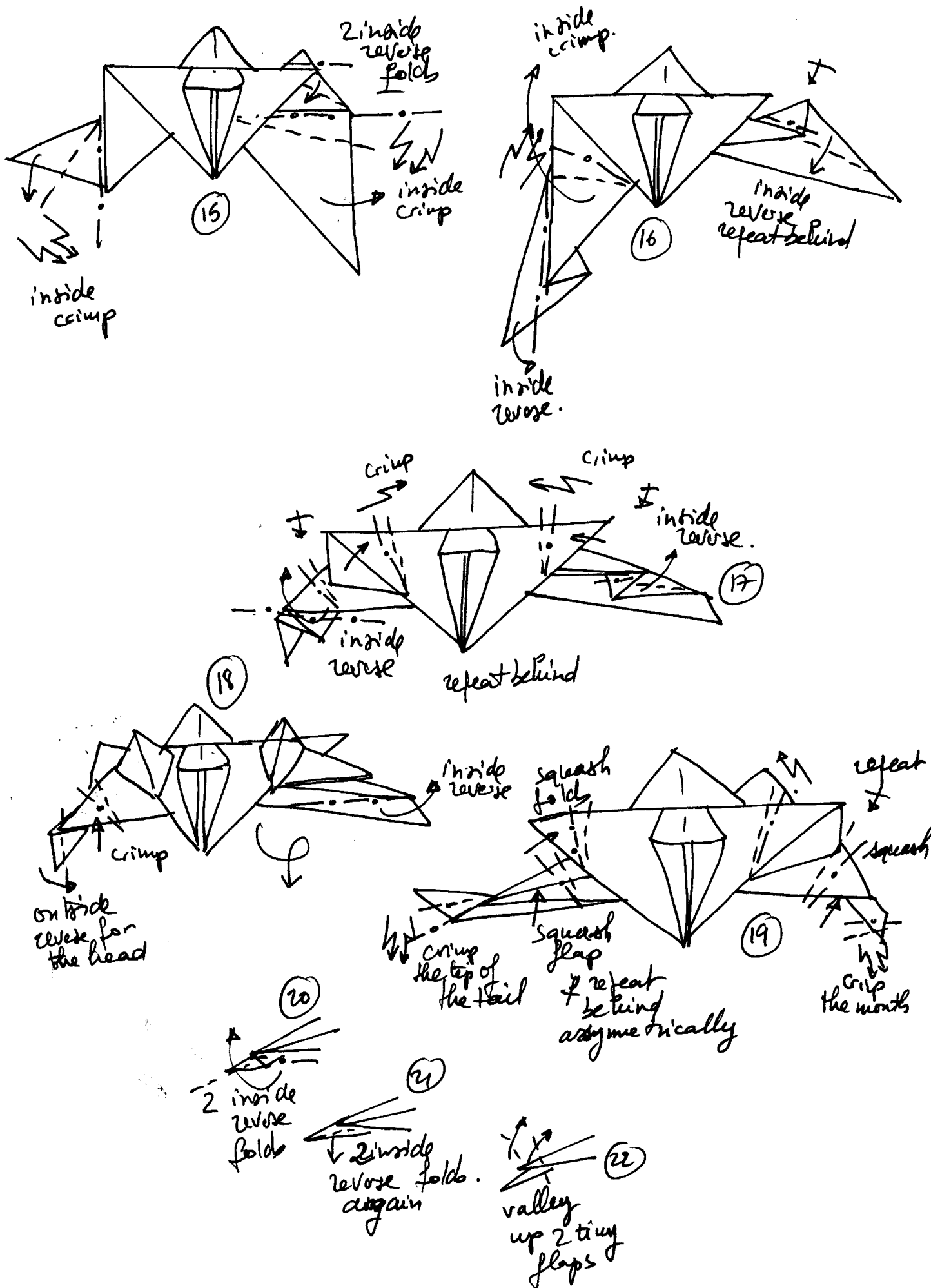

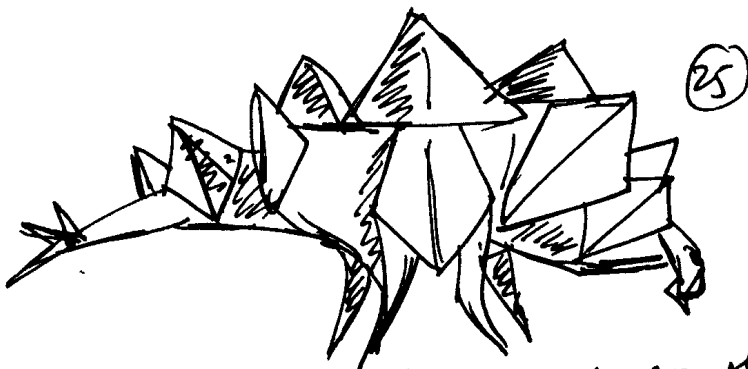
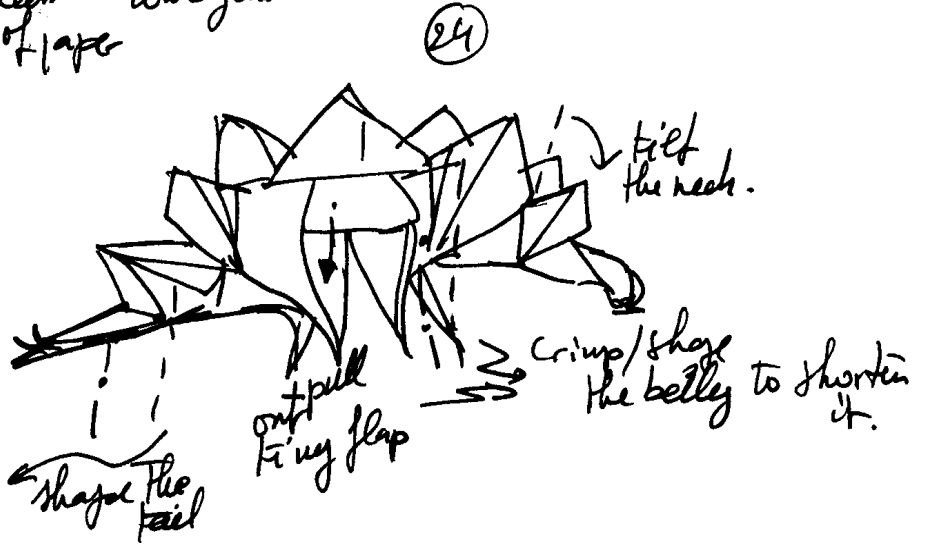
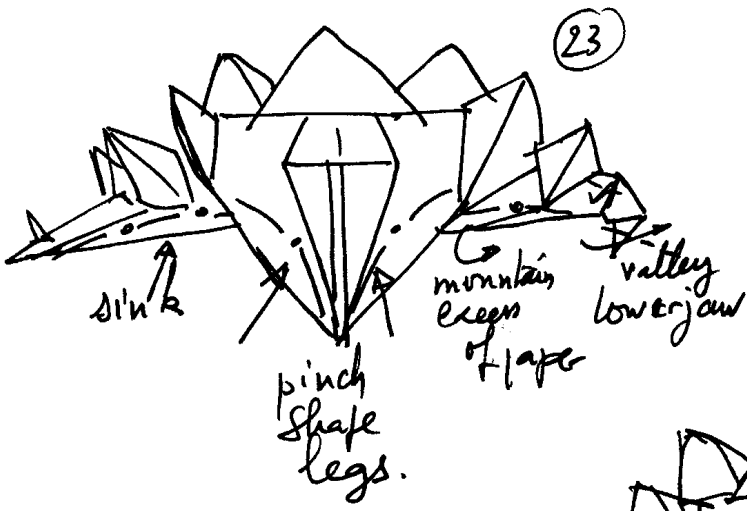

stegosaurus completed
February 2006
✱